

Despatch

Thermal Processing Technology

ITW EAE

LAC/LFC SERIES OVEN WITH PROTOCOL 3™ CONTROLLER OWNER'S MANUAL

C-266
PN 337069
VERSION 1.12
05/2018



SERVICE AND TECHNICAL SUPPORT

service parts: 1-800-473-7373
international service/main: 1-952-469-8230
service fax: 1-952-469-8193
service@despatch.com
usparts@itweae.com

GLOBAL HEADQUARTERS

main phone: 1-800-726-0110
international/main: 1-952-469-5424
sales: 1-800-726-0550
international/sales: 1-952-469-8240
sales@despatch.com

www.despatch.com

8860 207th Street West
Minneapolis, MN 55044 USA

Despatch
Thermal Processing Technology ITW EAE

Revision History

Revision	Date	Author	Description
1	03/2015	E. Anderson	Updated from base LAC manual C242. Updates include addition of LFC1-38 Class A, minor UL cleanup
1.1	04/2015	E. Anderson	Drawing restructure and solvent capabilities/safety update
1.11	09/2015	E. Anderson	Miscellaneous clean up and edits
1.12	05/2018	K. Livingston	Additions to clarify LFC operation.

Copyright © 2018 by Despatch Industries.

All rights reserved. No part of the contents of this manual may be reproduced, copied or transmitted in any form or by any means including graphic, electronic, or mechanical methods or photocopying, recording, or information storage and retrieval systems without the written permission of Despatch Industries, unless for purchaser's personal use.



Warning!

READ BEFORE OPERATING UNIT.

FAILURE TO HEED THIS WARNING CAN RESULT IN PROPERTY DAMAGE, SERIOUS BODILY INJURY OR DEATH



Hi-Limit Controls

We recommend a Hi-Limit control for all ovens and furnaces.

A hi-limit control is included on this unit.

It is installed to protect the equipment.

The location of the Hi-Limit Sensor element is at the supply duct louver and has been chosen to supervise that temperature. The Hi-Limit instrument should be set approximately 10 to 20 degrees F., higher than the maximum operating temperature. This setting will eliminate nuisance shutdowns when operating at the maximum temperature of the unit and still give maximum protection to the oven or furnace

DESPATCH INDUSTRIES CANNOT BE RESPONSIBLE FOR EITHER THE PROCESS OR THE QUALITY OF THE PRODUCT BEING PROCESSED.

If the product on which the equipment is being used is critical of over temperature the Hi-Limit should be used as a "Process Hi-Limit." The sensor element is located on the supply duct where the hot air enters work chamber. The temperature setting on the "Process Hi-Limit" should be set somewhat below the temperature at which the product would be damaged. If the product has an ignition temperature at which it could ignite, the setting should be well below this temperature. It is recommended that a certified instrument be used to make the proper setting.

IT IS THE PURCHASER'S RESPONSIBILITY THAT THE "EQUIPMENT HI-LIMIT" AND/OR THE "PROCESS HI-LIMIT" BE SET PER THE INSTRUCTIONS ON THIS SHEET AND ALSO THE INSTRUCTION SHEET FOR THE PARTICULAR HI-LIMIT INSTRUMENT FURNISHED WITH THIS UNIT.

Copyright © 2018 by Despatch Industries.

All rights reserved. No part of the contents of this manual may be reproduced, copied or transmitted in any form or by any means including graphic, electronic, or mechanical methods or photocopying, recording, or information storage and retrieval systems without the written permission of Despatch Industries, unless for purchaser's personal use.

Table of Contents

- 1. About This Manual..... 7
 - 1.1. Important User Information..... 7
 - 1.2. Manufacturer, Model Nomenclature & Service 8
 - 1.2.1. Model Nomenclature 8
 - 1.2.2. Service 9
 - 1.3. Organization of this Manual 9
 - 1.4. Conventions 10
 - 1.5. Specifications 11
 - 1.5.1. Dimensions 11
 - 1.5.2. Solvent Capabilities..... 11
 - 1.5.3. Capacities 12
 - 1.5.3.1. Solvent Capacity 13
 - 1.5.4. Power..... 13
 - 1.5.5. Temperature..... 14
 - 1.5.6. LAC-8 Series Oven Environmental Operating Conditions 14
- 2. Safety..... 16
 - 2.1. Safety Information..... 16
 - 2.1.1. Lockout..... 16
 - 2.1.1.1. Lockout Requirements..... 16
 - 2.1.1.2. Lockout Procedure..... 16
 - 2.1.2. Door and Panel 17
 - 2.2. Provisions for Lifting and Carrying..... 17
 - 2.3. Maintenance 18
 - 2.4. Electrical Power..... 18
 - 2.5. Fire..... 18
 - 2.6. Equipment Lockout Requirements 19
 - 2.6.1. Emergency Stop..... 19
 - 2.7. Disconnecting Devices 19
 - 2.7.1. Power Requirements..... 19
 - 2.7.2. Disconnecting Hard-Wired Units 19
 - 2.7.3. Disconnecting Corded Units..... 20
 - 2.7.4. Disconnecting Units with Optional Disconnect Switch 20
 - 2.8. Airflow Switches: Recirculation and Forced Exhaust..... 20
- 3. Theory of Operation 22
 - 3.1. The LAC-8 Series Oven 22
 - 3.2. LFC Specific Operation..... 23
 - 3.3. Damper Control 24
 - 3.3.1. Determining Damper Settings 24
 - 3.3.1.1. Damper Full Closed Position..... 24
 - 3.3.1.2. Damper Full Open Position 25
 - 3.3.1.3. Exhaust Damper Control for LFC-8 25
 - 3.3.1.4. Other Damper Settings 25
 - 3.4. The Protocol 3 Controller 26
- 4. Assembly & Setup..... 28
 - 4.1. Unpack & Inspect the LAC-8 Series Oven 28

Copyright © 2018 by Despatch Industries.

All rights reserved. No part of the contents of this manual may be reproduced, copied or transmitted in any form or by any means including graphic, electronic, or mechanical methods or photocopying, recording, or information storage and retrieval systems without the written permission of Despatch Industries, unless for purchaser's personal use.

4.1.1.	If Damaged During Shipping	28
4.2.	Set-Up the LAC-8 Series Oven	29
4.2.1.	Select Oven Location/Operating Environment.....	29
4.2.2.	Set-up Procedure	29
4.2.3.	Wiring & Power Connections	30
4.2.3.1.	Wire LAC-8 Models 2-12 and 2-18	31
5.	Operation.....	34
5.1.	Load Oven	34
5.2.	Pre-Startup Checklist.....	35
5.3.	Operating Procedure.....	36
5.3.1.	Start Oven.....	36
5.3.2.	Working with Protocol 3 Operating Modes	36
6.	Maintenance	37
6.1.	Checklist.....	37
6.2.	Test Airflow Switch and Purge Timer (LFC only; safety).....	38
6.3.	Lubrication	39
6.4.	Cleaning and Decontamination	39
6.4.1.	Cleaning the LAC-8 Series Oven	39
6.4.2.	Decontaminating the LAC-8 Series Oven	40
6.5.	Routine Tests.....	41
6.5.1.	Recirculation and Exhaust Airflow Switch Test Operation	41
6.5.1.1.	Alternative Method of Checking Power, Switches and Timer	42
6.5.1.2.	Recirculation And Exhaust Airflow Switch Adjustment.....	43
6.5.1.3.	Summary Switch Conditions.....	44
6.6.	Door Adjustment	45
6.7.	Replacement Parts	45
6.7.1.	Replace the Protocol 3 Controller	46
6.7.2.	Replace Heater Unit	47
6.7.3.	Replace Fan Motor	48
7.	Troubleshooting.....	49
7.1.	Troubleshooting Symptoms.....	49
7.2.	Troubleshooting Error Messages and Alarms	51
8.	Appendices	52
8.1.	Standard Products Warranty.....	52
8.2.	LAC-8 Series Oven Options.....	53
8.2.1.	Optional MRC5000 Recorder Setup.....	53
8.2.2.	Optional Pneumatic and Electronic Door Lock.....	54
8.2.3.	Optional Interior Light	54
8.2.4.	Optional Door Interlock Switch (Controls Heater & Fan)	54
8.2.5.	Optional High Limit Alarm with Alarm Silence	54
8.2.6.	Optional Forced Exhaust	55
8.2.7.	Optional Clean Dry Air (CDA)/Nitrogen.....	55
8.3.	Mechanical Drawings.....	56
8.4.	Electrical Schematics.....	56

Figures

Figure 1.	Disconnect Switch.....	20
Figure 2.	Locate the recirculation airflow switches in the control compartment.	21

Copyright © 2018 by Despatch Industries.

All rights reserved. No part of the contents of this manual may be reproduced, copied or transmitted in any form or by any means including graphic, electronic, or mechanical methods or photocopying, recording, or information storage and retrieval systems without the written permission of Despatch Industries, unless for purchaser's personal use.

Figure 3. Locate the forced exhaust airflow switch on the back of the oven. 21
Figure 4. LAC High-performance Bench-top Oven. 22
Figure 5. Horizontal Airflow through the LAC Oven. 22
Figure 6. Damper Positions. 25
Figure 7. LFC Oven Exhaust Damper Control. 25
Figure 8. Protocol 3 Controller Operator Interface. 27
Figure 9. LAC2-18-8 Nameplate. 31
Figure 10. Rear Access Panel for Hard-Wired Connections. 32
Figure 11. Control panel removal. 32
Figure 12. Power Connections at Main Circuit Board. 33
Figure 13. Circuit Board. 39
Figure 14. Test Recirculation and Exhaust Airflow Switches. 42
Figure 15. Oven Control Circuit Board LEDs indicate status of switches. 43
Figure 16: Shipping anchors Figure 17: Wall separator/anchor 45
Figure 18: Latch Adjustment Figure 19: Spring removal. 45
Figure 20. Remove Screws to Remove Ceiling Plate. 47
Figure 21. Heater Panel and Inlet Cone. 47
Figure 22. Remove Heater Panel by Removing Screw in Front Edge of Each Panel. 48

Tables

Table 1. Operating/Environmental Conditions (For indoor use). 15
Table 2. Troubleshooting Oven Symptoms. 49
Table 3. Troubleshooting with Control Panel Mounted Circuit Board. 50
Table 4. Error Messages and Next Steps. 51
Table 5. MRC 5000 Settings. 53

1. About This Manual





1.1. Important User Information

Copyright © 2018 by Despatch Industries.

All rights reserved. No part of the contents of this manual may be reproduced, copied, or transmitted in any form or by any means including graphic, electronic, or mechanical methods or photocopying, recording, or information storage and retrieval systems without the written permission of the publisher, unless it is for the purchaser's personal use.

The information in this manual is subject to change without notice and does not represent a commitment on the part of Despatch Industries. Despatch Industries does not assume any responsibility for any errors that may appear in this manual.

In no event will Despatch Industries be liable for technical or editorial omissions made herein, nor for direct, indirect, special, incidental, or consequential damages resulting from the use or defect of this manual.

	<p><i>For here forward, <u>unless noted otherwise</u> the LFC nomenclature may be substituted for LAC, as LAC is the series or family of models upon which the LFC is built. Note the LAC may <u>NEVER</u> be operated with solvents present.</i></p>
	<p><i>Before operating this equipment, carefully read instruction manual.</i></p>
	<p><i>Values displayed on screens are examples only. Though those values may be typical, contact Despatch Industries for the final value.</i></p>
	<p><i>Users of this equipment must comply with operating procedures and training of operation personnel as required by the Occupational Safety and Health Act (OSHA) of 1970, Section 5 and relevant safety standards, as well as other safety rules and regulations of state and local governments. Refer to the relevant safety standards in OSHA and National Fire Protection Association (NFPA), section 86 of 1990.</i></p>

Copyright © 2018 by Despatch Industries.

All rights reserved. No part of the contents of this manual may be reproduced, copied or transmitted in any form or by any means including graphic, electronic, or mechanical methods or photocopying, recording, or information storage and retrieval systems without the written permission of Despatch Industries, unless for purchaser's personal use.

	<p>Danger!</p> <p><i>Only fully-trained and qualified personnel should setup and maintain this equipment. Improper setup and operation of this equipment could cause an explosion that may result in equipment damage, personal injury or possible death.</i></p>
---	--

The information in this document is not intended to cover all possible conditions and situations that might occur. The end user must exercise caution and common sense when installing or maintaining Despatch Industries products. If any questions or problems arise, call Despatch Industries at **1-888-DESPATCH** or **1-952-469-5424**.

1.2. Manufacturer, Model Nomenclature & Service

The LAC-8 Series oven is manufactured by Despatch Industries.

1.2.1. Model Nomenclature

The LAC series of laboratory ovens uses a suffix to indicate the current revision level. LAC-8, the current oven revision, refers to the oven's eighth revision.

- The LAC series of laboratory ovens consist of four Class-B oven models:
 - LAC 1-38-8
 - LAC 1-67-8
 - LAC 2-12-8
 - LAC 2-18-8

	<p><i>The LAC Series of ovens are not configured for handling flammable solvents.</i></p>
---	--

- The LFC series of laboratory ovens includes two class-A oven models configured for safe handling of a limited amount of solvent when the oven is loaded at room temperature:
 - LFC1-38-8
 - LFC2-12-8

	<p>Danger!</p> <p><i>Never load a hot oven. Wait for a hot oven to cool before loading.</i></p>
---	---

Copyright © 2018 by Despatch Industries.

All rights reserved. No part of the contents of this manual may be reproduced, copied or transmitted in any form or by any means including graphic, electronic, or mechanical methods or photocopying, recording, or information storage and retrieval systems without the written permission of Despatch Industries, unless for purchaser's personal use.

1.2.2. Service

Despatch has specialized in thermal processing for over 100 years. Technical expertise gained over those years helps provide innovative solutions to critical applications in vertical markets and cutting edge technology worldwide. Despatch products are backed by a drive for long-term customer satisfaction and a strong sense of responsibility. The worldwide network of factory-trained Service Professionals is available to support your Despatch equipment. From full service preventive maintenance to routine repair and certified calibration and uniformity, the Despatch service network is positioned to respond to your business needs. Our service programs are customized to meet your specific needs using our Advantage Service Assurance Program (ASAP). For more information on ASAP, visit www.despatch.com.



Global Headquarters	Contact	Service & Technical Support
Despatch Industries 8860 207th Street Lakeville, MN 55044 USA	International/Main: 1-952-469-5424 US toll free: 1-888-337-7282 Fax: 1-952-469-4513 info@despatch.com www.despatch.com	Service: 1-952-469-8230 US toll free: 1-800-473-7373 Service @despatch.com

1.3. Organization of this Manual

This owner's manual contains the most comprehensive set of information for the Despatch LAC-8 Series ovens, including installation instructions, theory of operation, operating instructions, among other things.

	<p><i>Danger!</i></p> <p><i>Failure to heed warnings in this instruction manual and on the oven could result in personal injury, property damage or death.</i></p>
---	--

1.4. Conventions

	<i>This icon signifies information that describes an unsafe condition that may result in death, serious injury, or damage to the equipment.</i>
Danger!	<i>Danger is the signal word used to indicate a hazardous situation that, if not avoided, will result in death or severe injury.</i>
Warning!	<i>Warning is the signal word used to indicate a hazardous situation that, if not avoided, could result in death or severe injury.</i>
Caution!	<i>Caution is the signal word used to indicate a hazardous situation that, if not avoided, could result in moderate or minor injury.</i>
Notice	<i>Notice is the signal word used to indicate a hazardous situation that, if not avoided, could result in property damage.</i>
	<i>This icon signifies supplemental important information.</i>

Copyright © 2018 by Despatch Industries.

All rights reserved. No part of the contents of this manual may be reproduced, copied or transmitted in any form or by any means including graphic, electronic, or mechanical methods or photocopying, recording, or information storage and retrieval systems without the written permission of Despatch Industries, unless for purchaser's personal use.

1.5. Specifications

1.5.1. Dimensions

LAC Model No.	Chamber Size in (cm)			Capacity feet ³ (liters)	Overall Size in (cm)			Max. Number of Shelf Positions	Exhaust Diameter Located on Back of Chamber in (cm)
	W*	D	H		W	D	H		
LAC 1-38	19 (48)	18 (45)	19 (48)	3.8 (105)	31 (78)	27 (69)	38 (96)	9	2.5 (6.4)
LFC 1-38	19 (48)	18 (45)	19 (48)	3.8 (105)	31 (78)	33 (84)	38 (97)	9	4.0 (10.2)
LAC 1-67	24 (61)	20 (50)	24 (62)	6.7 (189)	36 (91)	29 (74)	43 (110)	11	2.5 (6.4)
LAC 2-12	24 (61)	24 (61)	36 (91)	12 (340)	36 (91)	33 (84)	55 (139)	17	2x - 2.5 (2x - 6.4)
LFC 2-12	24 (61)	24 (61)	36 (91)	12 (336)	36 (91)	39 (100)	55 (139)	17	4.0 (10)
LAC 2-18	36 (90)	24 (61)	36 (91)	18 (510)	47 (120)	33 (84)	55 (139)	17	2x - 2.5 (2x - 6.4)

Notice	<i>Refer to engineering drawings for exact dimensions.</i>
---------------	---

1.5.2. Solvent Capabilities

	<p><i>The LAC-8 oven is not intended to process solvents or other volatile or flammable materials. Oven exhaust is intended for cooling purposes only.</i></p> <p><i>The LFC is designed to handle solvents up to the stated ratings in this manual and on the oven name plate.</i></p>
---	---

* Allow 0.5" (1cm) clearance on each side for shelf supports.

Copyright © 2018 by Despatch Industries.

All rights reserved. No part of the contents of this manual may be reproduced, copied or transmitted in any form or by any means including graphic, electronic, or mechanical methods or photocopying, recording, or information storage and retrieval systems without the written permission of Despatch Industries, unless for purchaser's personal use.

	<p>Warning!</p> <p><i>Do not place this oven in an environment harmful to electrical components.</i></p> <p><i>Placing this oven in an environment detrimental to electrical components (for example, environments where carbon fibers, coal dust or similar contaminants may be present) may result in component failure.</i></p> <p><i>Do not use liquids in the oven. Do not set product or liquids on top of the oven. Liquids that may spill on the oven floor or top of oven may cause considerable damage to the oven.</i></p> <p><i>Contact Despatch for options available to help prevent such failures.</i></p>
---	--

1.5.3. Capacities

LAC-8 Model Number		LAC1-38-8 120V & 240V	LFC 1-38-8	LAC 1-67-8	LAC 2-12-8	LFC 2-12-8	LAC 2-18-8
Maximum Load	Lbs (Kg)	175 (79)	175 (79)	250 (113)	300 (136)	300 (136)	300 (136)
Maximum Shelf Load	Lbs (Kg)	50 (23)	50 (23)	50 (23)	50 (23)	50 (23)	50 (23)
Exhaust	CFM	Adjustable to 12	Adjustable From 13 to 41	Adjustable to 12	Adjustable to 30	Adjustable From 13 to 41	Adjustable to 40
Recirculating Fan	CFM	300	300	300	600	600	600
	H.P.	¼	¼	¼	¼ x 2	¼ x 2	¼ x 2
Number of Doors		1	1	1	1	1	2
Approx. Weight Net	Lbs	185	185	255	360	370	450
	KG	84	84	116	163	168	204
Shipping Weight	Lbs	280	290	365	480	490	585
	KG	127	132	166	218	222	266

Copyright © 2018 by Despatch Industries.

All rights reserved. No part of the contents of this manual may be reproduced, copied or transmitted in any form or by any means including graphic, electronic, or mechanical methods or photocopying, recording, or information storage and retrieval systems without the written permission of Despatch Industries, unless for purchaser's personal use.

1.5.3.1. Solvent Capacity

LAC-8 Model Number		LAC1-38-8 120V & 240V	LFC 1-38-8	LAC 1-67-8	LAC 2-12-8	LFC 2-12-8	LAC 2-18-8
Solvent Capacity	GPH	None	0.02	None	None	0.02	None

1.5.4. Power

If the line voltage for your LAC-8 Series oven varies more than 10% from the oven voltage rating, electrical components such as relays and temperature controls may operate erratically. Heater upgrade will change power requirements.

- If the line voltage is lower than the oven voltage rating, heat-up time may be significantly longer and motors may overload or run hot
- If the line voltage is higher than the nameplate rating, motors may run hot and draw excessive amperage

Model	Volts	Amps	Hertz	Phase	Heater KW	Cord and Plug
LAC1-38-8	120	16.3	50/60	1	1.6	Included, 20 Amp (NEMA 5-20)
LAC1-38-81†	240	10.5	50/60	1	1.8	Included, 15 Amp (NEMA 6-15)
	208	10.8			1.8	
LFC1-38-8†	240	22.7	50/60	1	4.8	None, Hardwired. Branch circuit rated device 30A.*
	208	31.8			4.8	None, Hardwired. Branch circuit rated device 40A.*
LAC1-67-8†	240	12.4	50/60	1	2.4	Included, 15 Amp (NEMA 6-15)
	208	14.1			2.4	
LAC2-12-8†‡	240	24.2	50/60	1	4.8	None, Hardwired. Branch circuit rated device 35A.*
	208	26.7			4.8	None, Hardwired. Branch circuit rated device 35A.*

† The LAC Series oven designed for 240 volts (see oven nameplate) will operate satisfactorily on a minimum of 208 Volts, but will result in 25% reduced heater output. If your power characteristic is lower, contact Despatch Industries. An option is available to regain the full heater power when operating on 208V.

‡ The LAC 2-12 and LAC 2-18 must be hardwired to the electric supply using 10 AWG (8 AWG on LAC2-18-8 208V full power option) or larger wires suitable for at least 75 °C (167 °F).

LFC2-12-8†	240	29.1	50/60	1	6	None, Hardwired. Branch circuit rated device 40A.*
	208	33.5			6	None, Hardwired. Branch circuit rated device 50A.*
LAC2-18-8†‡	240	24.2	50/60	1	4.8	None, Hardwired. Branch circuit rated device 30A.*
	208	27.8			4.8	None, Hardwired. Branch circuit rated device 35A.*

*The overcurrent protection means provided by the building mains supply circuit shall be a branch circuit rated protection device.

1.5.5. Temperature

LAC-8 Model Number	LFC 1-38	LFC 2-12	1-38 120V	1-38 240V	LAC 1-67	LAC 2-12	LAC 2-18
Time to Temperature 40 °C – 100 °C (approximate minutes)	4	5	9	6	6	7	5
With dampers closed and no load) 40 °C – 200 °C	13	18	35	25	26	18	20
– 260 °C	20	30	60	45	40	35	45
Recovery Time - Door Open 100 °C	N/A	N/A	1	1	1	1	1
One Minute (approximate 200 °C			6	4	3	6	4
minutes with no load) * 260 °C			14	8	5	9	8
Temperature Uniformity at 100 °C§	± 2 % of set-point		± 1 ° C ± 2 ° C ± 2.5 ° C				
200 °C§							
260 °C§							
Operating Range with 20 °C Ambient	40 °C – 260 °C						
Control Stability	± 0.5 °C per 5 °C change in ambient						
Repeatability	± 0.5° C						

*Recovery time as measured at control thermocouple.

1.5.6. LAC-8 Series Oven Environmental Operating Conditions

The LAC-8 Series oven is for indoor use. Table 1 provides the operating conditions.

§ Figures are based on actual tests in an empty oven. Uniformity can vary slightly depending on unit and operating conditions.

Copyright © 2018 by Despatch Industries.

All rights reserved. No part of the contents of this manual may be reproduced, copied or transmitted in any form or by any means including graphic, electronic, or mechanical methods or photocopying, recording, or information storage and retrieval systems without the written permission of Despatch Industries, unless for purchaser's personal use.

Table 1. Operating/Environmental Conditions (For indoor use).

Item	Description
Operating Temperature**	18°C to 40°C (64.4°F to 104°F)
Relative Humidity	70% non-condensing
Maximum Altitude	2,000 meters (6,600 feet)

** Fluctuations in temperature can occur at elevated ambient temperature values.

2. Safety

2.1. Safety Information

Do not work on the LAC-8 Series oven without reading and understanding this section which contains important information and warnings. The LAC is not designed to handle any amount of solvents, while the LFC can handle up to the rated amount stated in this manual. Ignoring these warnings can result in death, serious injury or damage to the machine and product.

2.1.1. Lockout



Carefully follow the established Lock Out Tag Out policies of your company in all cases.



Danger!

An accidental start-up, while working on the LAC-8 Series oven, can result in serious injury or death.

Machine lockout places the LAC-8 Series oven into a zero energy state and prevents accidental machine start up. Always follow the Lockout Procedure described in this Section before cleaning, maintaining or repairing the LAC-8 Series oven. An accidental start-up, while working on the LAC-8 Series oven, can result in serious injury or death.

2.1.1.1. Lockout Requirements

1. Every power source that can energize any element of the LAC-8 Series oven must be shut off at the closest possible power source. This includes air, water and electricity, including the Disconnect Switch.
2. After energy sources are locked out, test to ensure circuits are de-energized.

2.1.1.2. Lockout Procedure



Danger!

Electrical panels contain high voltage. Disconnect and lock out the power supply before working inside any electrical panels. Failure to lock out the power supply can result in death or injury.

Personnel authorized to lockout equipment must have the necessary locks to perform the lockout.

1. Physically disconnect all electrical power to the machine or lockout the appropriate breaker or disconnects.

Copyright © 2018 by Despatch Industries.

All rights reserved. No part of the contents of this manual may be reproduced, copied or transmitted in any form or by any means including graphic, electronic, or mechanical methods or photocopying, recording, or information storage and retrieval systems without the written permission of Despatch Industries, unless for purchaser's personal use.

2. Close all valves and bleed off any pressure.
3. Test for power by attempting a start with the machine controls.
4. Identify the Lockout Condition with a tag on the electrical disconnect and pneumatic shut off valve.
5. When work is complete, remove all tags and restore the machine to its working state.

	<p>Danger!</p> <p><i>Electrical panels contain high voltage. Disconnect and lock out the power supply before working inside any electrical panels. Failure to lock out the power supply can result in death or injury.</i></p>
---	---

2.1.2. Door and Panel

A properly secured control panel on the LAC-8 Series oven protects against hazards. Operation without the control panel in place creates hazards that the control panel is intended to render safe for personnel.

2.2. Provisions for Lifting and Carrying

	<p>Caution!</p> <p><i>Do not tilt oven while lifting. Do not lift oven using the door handle to prevent damage to the oven and/or personnel involved.</i></p>
---	--

	<p>Caution!</p> <p><i>Do not risk injury when lifting equipment. Take proper precautions when lifting, carrying or otherwise maintaining heavy items.</i></p>
---	--

<p>Notice</p>	<p>How to lift the different sizes of ovens:</p> <ul style="list-style-type: none">• LAC1-38: Four people lift oven's lower corners and place on wheeled transport pallet. Push pallet to desired site and lift oven from pallet, again lift using lower corners.• LAC1-67, LAC2-12 & LAC2-18: Do not lift by hand. Lift with fork lifter and transport pallet.
----------------------	---

Copyright © 2018 by Despatch Industries.

All rights reserved. No part of the contents of this manual may be reproduced, copied or transmitted in any form or by any means including graphic, electronic, or mechanical methods or photocopying, recording, or information storage and retrieval systems without the written permission of Despatch Industries, unless for purchaser's personal use.

2.3. Maintenance

Only qualified and trained personnel should perform maintenance or repair.

2.4. Electrical Power

Only qualified and trained personnel should perform electrical maintenance or electrical repair.

	<p>Danger!</p> <p><i>Contact with energized electrical sources may result in serious injury or death.</i></p>
---	--

- Before performing maintenance, disconnect all electrical power from the machine. Use a padlock and lockout all disconnects feeding power to the machine.
- Never clean or repair the oven when in operation.
- Unauthorized alterations or modifications to LAC-8 Series oven are strictly forbidden. Never modify any electrical circuits. Unauthorized modifications can impair the function and safety of the LAC-8 Series oven.

	<p>Warning!</p> <p><i>Do not place this oven in an environment harmful to electrical components.</i></p> <p><i>Placing this oven in an environment detrimental to electrical components (for example, environments where carbon fibers, coal dust or similar contaminants may be present) may result in component failure.</i></p> <p><i>Do not use liquids in the oven. Do not set product or liquids on top of the oven. Liquids that may spill on the oven floor or top of oven may cause considerable damage to the oven.</i></p> <p><i>Contact Despatch for options available to help prevent such failures.</i></p>
---	--

2.5. Fire

Keep the LAC-8 Series oven clean and free of scrap materials, oil or solvents to prevent the possibility of fire. In the event of fire, use a fire extinguisher as follows.

1. Leave door as it is.
2. De-energize the machine immediately by turning OFF the **DISCONNECT SWITCH**.

Copyright © 2018 by Despatch Industries.

All rights reserved. No part of the contents of this manual may be reproduced, copied or transmitted in any form or by any means including graphic, electronic, or mechanical methods or photocopying, recording, or information storage and retrieval systems without the written permission of Despatch Industries, unless for purchaser's personal use.

3. Turn off the remote main disconnect (customer supplied disconnect).
4. Shut off fuel.
5. Call the fire department.
6. Stay away.

	<p>Danger!</p> <p><i>Always disconnect all power before extinguishing a fire. Attempting to extinguish a fire in a machine connected to electrical power can result in serious injury or death.</i></p>
---	--

2.6. Equipment Lockout Requirements

To prevent injury or equipment damage during inspection or repair, the LAC-8 Series oven must be locked out.

2.6.1. Emergency Stop

When a risk of personal injury or damage to the LAC-8 Series oven exists, turn OFF the oven by removing/unplugging the cord. This shuts off all electrical power to the oven.

2.7. Disconnecting Devices

2.7.1. Power Requirements

Despatch recommends the LAC-8 have unobstructed access to a dedicated power source.

	<p><i>Use a power stabilizer if voltage fluctuation is greater than $\pm 10\%$ nominal voltage fluctuation.</i></p>
---	--

2.7.2. Disconnecting Hard-Wired Units

LAC-8 permanently-connected (hard-wired) ovens include models LAC2-12-8 and LAC2-18-8. Permanently-connected and multi-phased equipment must employ a switch or circuit-breaker as means for disconnection. For permanently-connected equipment, installation instructions must specify a switch or circuit-breaker is included during the facility oven installation for complete isolation.

The disconnecting device must be installed in close proximity to the equipment and within easy reach of the operator. The disconnecting device must be marked as the disconnecting device for the equipment. If the unit is equipped with an ON/OFF switch, mark the ON/OFF position clearly.

Copyright © 2018 by Despatch Industries.

All rights reserved. No part of the contents of this manual may be reproduced, copied or transmitted in any form or by any means including graphic, electronic, or mechanical methods or photocopying, recording, or information storage and retrieval systems without the written permission of Despatch Industries, unless for purchaser's personal use.



Follow local codes and requirements for installing and using disconnect switches.



Danger!

Keep switch or circuit-breaker in building installation, close to the equipment, within easy reach of the operator and clearly marked.

2.7.3. Disconnecting Corded Units

LAC-8 cord-connected ovens include models LAC1-38-8 and LAC1-67-8. To disconnect a corded unit, unplug the cord from the power source.

2.7.4. Disconnecting Units with Optional Disconnect Switch

The LAC-8 Series oven has an optional Disconnect Switch. This Disconnect Switch is located on the front of the oven, typically near the controls, and connected to the load break switch behind the panel that disconnects or connects power from the main line. When a risk of personal injury or damage to the LAC-8 Series oven exists, turn off the Disconnect Switch. This shuts off all electrical power to the oven.



Figure 1. Disconnect Switch.

2.8. Airflow Switches: Recirculation and Forced Exhaust

The airflow switch is used to prove airflow at the recirculation and exhaust fans when the heater is being energized in the LFC Oven. The model LFC1-38-8 has two airflow switches (one recirculation switch and one exhaust switch) while the model LFC2-12-8 has three airflow switches (two recirculation switches and one exhaust switch).

- Locate the recirculation fan airflow switches in the control compartment (Figure 2).
- Locate the forced exhaust fan on the back of the oven (Figure 3).

For test and operation of the airflow switches, refer to Section 6.5.1.

Copyright © 2018 by Despatch Industries.

All rights reserved. No part of the contents of this manual may be reproduced, copied or transmitted in any form or by any means including graphic, electronic, or mechanical methods or photocopying, recording, or information storage and retrieval systems without the written permission of Despatch Industries, unless for purchaser's personal use.

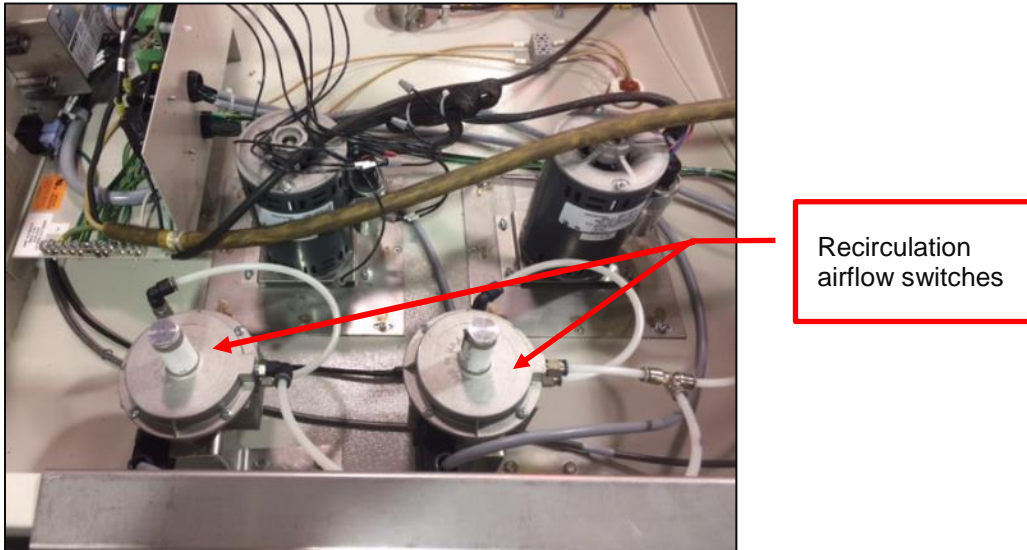

Figure 2. Locate the recirculation airflow switches in the control compartment.



Figure 3. Locate the forced exhaust airflow switch on the back of the oven.

Copyright © 2018 by Despatch Industries.

All rights reserved. No part of the contents of this manual may be reproduced, copied or transmitted in any form or by any means including graphic, electronic, or mechanical methods or photocopying, recording, or information storage and retrieval systems without the written permission of Despatch Industries, unless for purchaser's personal use.

3. Theory of Operation

3.1. The LAC-8 Series Oven

The LAC-8 high-performance bench-top oven uses digitally-controlled, horizontal recirculating airflow to ensure uniform temperatures throughout the oven for fast-processing (Figure 4). A high-volume fan circulates air through perforated, stainless steel walls to create a constant horizontal airflow across all sections of the oven (Figure 5). The result is proven reliability in demanding production and laboratory applications such as curing, drying, sterilizing, aging and other process-critical procedures.

The LAC-8 oven is especially useful for testing, preheating, sterilizing, drying, aging and curing along with other production applications. The overall result is efficient productivity under strenuous conditions. The chamber can be densely loaded without interfering with the process. Air delivery temperature is within 1°C of the number appearing on the digital display. Fresh air intake is regulated by a panel-mounted damper control, while the exhaust opening is fixed. The exhaust port, on the back of the oven, is covered by a hat bracket.



Figure 4. LAC High-performance Bench-top Oven.

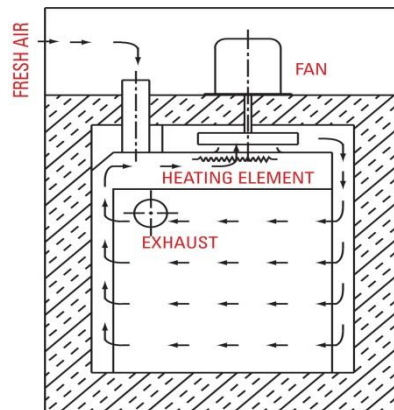

Figure 5. Horizontal Airflow through the LAC Oven.

	Warning!
<p><i>Note that the LAC-8 Oven may not be used with flammable materials. If operating with flammable materials, please ensure that the nameplate states that the oven is an LFC, and follow the operating instructions for safe operation.</i></p>	

Copyright © 2018 by Despatch Industries.

All rights reserved. No part of the contents of this manual may be reproduced, copied or transmitted in any form or by any means including graphic, electronic, or mechanical methods or photocopying, recording, or information storage and retrieval systems without the written permission of Despatch Industries, unless for purchaser's personal use.



Warning!

Do not remove the hat bracket (located in rear of oven) as it distributes exhaust air and protects the exhaust opening from being completely covered.

3.2. LFC Specific Operation

The LFC Class A oven is built from the base LAC laboratory oven. All required Class A-compliant features and components are added to meet NFPA 86 requirements. Additions include:

- Positive latch
- Pressure relief panel
- Purge timer
- Recirculation fan airflow switch
- Airflow switches and exhaust fan

Notice

All required Class A-compliant features and components are added to the LCD Class A oven to meet NFPA 86 requirements. These added measures are designed to safely handle volatile organics and other solvent byproducts.

These measures alone cannot guarantee safety.

The LFC Class A Oven owner/operator must take measures to ensure appropriate solvent levels are observed and that the equipment is operated according to proper procedures outlined by the NFPA and this manual.

The fresh air intake is designed such that when the intake damper is in the Closed position, it still permits the minimum air into the system allowed by NFPA 86 requirements.

Notice

Never block the fresh air intake.

The exhaust damper is designed in the same manner as the fresh air intake: to ensure an adequate air mixture, as well as to facilitate removal of solvent-laden air from the system.

An airflow switch is employed as a safety mechanism to ensure that airflow is not inadvertently cut off. The purge timer ensures the chamber has made a sufficient number of exchanges to safely turn on the heater at the start of a process. An explosion relief panel is required based on the internal volume, temperature, and allowable solvent rating (for more information, refer to specifications Section 1.5. The explosion relief panel provides for a safe and known outlet for additional energy caused by an explosion or other pressure build up. The area around this panel must be free of obstruction.

Copyright © 2018 by Despatch Industries.

All rights reserved. No part of the contents of this manual may be reproduced, copied or transmitted in any form or by any means including graphic, electronic, or mechanical methods or photocopying, recording, or information storage and retrieval systems without the written permission of Despatch Industries, unless for purchaser's personal use.

	<p>Danger!</p> <p><i>Class A [LFC] ovens are designed for a specific amount of solvent. Exceeding this amount could result in an explosion. Do not process closed containers of any substance or liquid in this oven because they may explode under heat. In case of fire, leave door(s) as they are. Shut off electricity. Shut off fuel. Call the fire department. Stay away.</i></p>
---	--

3.3. Damper Control

The LAC-8 oven is equipped with a manually-adjustable damper mechanism. The damper control arm is located on the front panel of the oven (Figure 1). The damper adjustment controls the fresh air opening which, due to pressurization of the oven chamber, controls the flow of exhaust. If the damper is in the full open position, the maximum exhaust rate is achieved. If the damper is in the fully closed position, the minimum exhaust rate is achieved.

3.3.1. Determining Damper Settings

The optimum setting for the damper depends on a variety of factors. These factors include ambient environment temperature, load conditions, load distribution, heat-up and cool-down rates, desired temperature uniformity and most importantly the desired operating temperature. Additionally, engineering tradeoffs for each factor must be carefully weighed. While considering each factor independently may be too daunting, guidelines provide a simpler way to determine damper settings.

In general, set the damper so the amount of fresh air flowing into and exhausting from the chamber agrees with the desired operating temperature conditions. The following outline provides practical considerations for various damper position settings (Figure 3).

<p>Notice</p>	<p><i>For an LFC oven: with the air intake and exhaust dampers in full closed position, a predetermined amount of fresh air enters the chamber via cutaways in the fresh air and exhaust dampers. This amount of fresh air meets NFPA86 Safety Guidelines for Class A ovens. The fresh air intake and exhaust should NEVER be completely blocked or restricted.</i></p>
---------------	---

3.3.1.1. Damper Full Closed Position

The damper in full closed position allows maximum attainable heat-up rates for the chamber. In addition, the chamber uses minimum power to operate at



Copyright © 2018 by Despatch Industries.

All rights reserved. No part of the contents of this manual may be reproduced, copied or transmitted in any form or by any means including graphic, electronic, or mechanical methods or photocopying, recording, or information retrieval systems without the written permission of Despatch Industries, unless for purchaser's personal use.

the desired temperature. In most cases, maintain the damper in the full closed position to efficiently operate at the maximum operating temperature for the chamber.

3.3.1.2. Damper Full Open Position

The damper in full open position allows minimum operating temperature for the chamber. Friction heat from the air recirculation system builds up in the chamber. This causes chamber temperature to rise slightly though the heating system is not ON. After the recirculation motor has been ON for an extended period of time, the chamber reaches a thermal equilibrium temperature.

When the damper is not set to full open position, the chamber has no way to readily dissipate the heat generated by the friction. With the damper fully open, the thermal equilibrium temperature is the minimum operating temperature of the chamber.

Figure 6. Damper Positions.

	<p><i>When the damper is in the full open position, the oven may not be able to heat to the maximum oven operating temperature.</i></p>
---	--

Notice	<p><i>Over-pressurizing the chamber can cause hot air to blow out around the door seal and cause the area around the door to be hot to the touch. Stop this hot air from entering the room by closing the damper slightly until the air stops blowing.</i></p>
---------------	---

3.3.1.3. Exhaust Damper Control for LFC-8

Adjusting the exhaust damper aids in pressuring the oven chamber (Figure 7). The damper is designed so that it may never be fully closed.

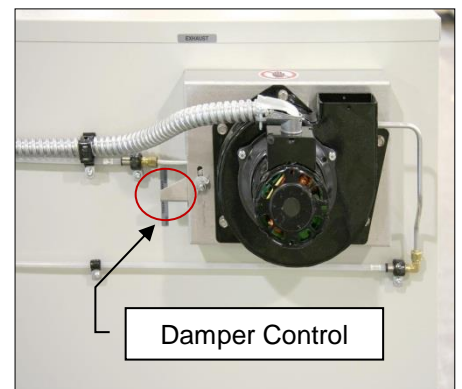

Figure 7. LFC Oven Exhaust Damper Control.

3.3.1.4. Other Damper Settings

The damper can be set to several other distinct operating positions. In most cases the damper setting is influenced by two specific performance factors: uniformity and cool-down rates.

Copyright © 2018 by Despatch Industries.

All rights reserved. No part of the contents of this manual may be reproduced, copied or transmitted in any form or by any means including graphic, electronic, or mechanical methods or photocopying, recording, or information storage and retrieval systems without the written permission of Despatch Industries, unless for purchaser's personal use.

Chamber Uniformity

The system's inside chamber pressure influences chamber uniformity. Pressure inside the chamber depends on the amount of fresh air flowing into the chamber. When a large volume of fresh air flows into the chamber, the chamber pressurizes slightly and overall temperature uniformity improves. The slightly pressurized chamber produces the effect of "pushing" air to the corners of the chamber. Typically the corners of the chamber improve with respect to temperature distribution while the core of the chamber maintains excellent uniformity characteristics regardless of damper position.

Pressurization of the chamber typically is a factor when the chamber is loaded heavily. The best uniformity results, with respect to the product, are achieved when no more than two-thirds of any inside chamber dimension are used. The best overall results are achieved when the product(s) are located in the center of the chamber.

Cool-Down Rates

The more open the damper, the faster the cool-down.

3.4. The Protocol 3 Controller

The Protocol 3 is a microprocessor based digital temperature controller designed for simple and flexible oven operation (Figure 8). The Protocol 3 controller operates as a dual-functioning controller/High Limit instrument. The control portion utilizes a time proportioning voltage signal to control heating devices with minimal temperature fluctuations.

The High Limit portion protects the product and/or the oven from overheating. If the product being processed has a critical high temperature limit, the High Limit setpoint should be set to a temperature somewhat below the temperature at which the product could be damaged. If the product does not have a critical high temperature limit, the High Limit setpoint should be set 5 to 15 degrees higher than the maximum programmed setpoint at which the oven will operate.

The Protocol 3 controller provides three primary operating modes:

- **Manual:** Oven operates continuously at a fixed temperature until turned off.
- **Timer:** Oven operates at a fixed temperature for a user-selected time period, and then automatically turns off.
- **Profile:** Temperatures increase or decrease as defined by 255 segments that can be allocated to 64 ramp and soak profiles. The profiles can be linked to provide additional temperature combinations.

Review the Protocol 3 Controller Owner's Manual for more information.

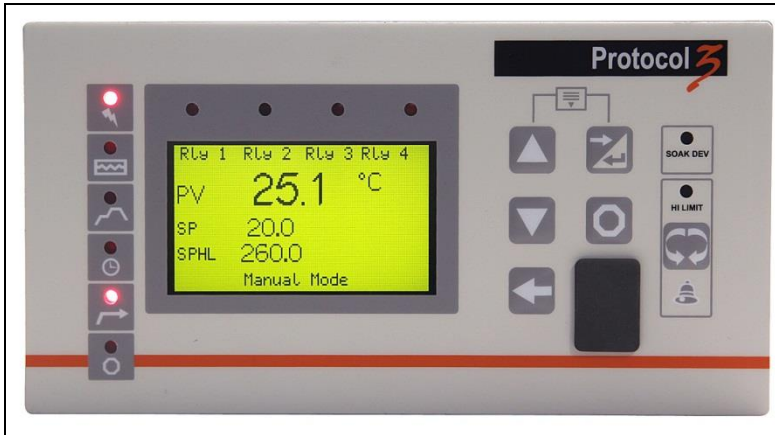

Figure 8. Protocol 3 Controller Operator Interface.

Copyright © 2018 by Despatch Industries.

All rights reserved. No part of the contents of this manual may be reproduced, copied or transmitted in any form or by any means including graphic, electronic, or mechanical methods or photocopying, recording, or information storage and retrieval systems without the written permission of Despatch Industries, unless for purchaser's personal use.

4. Assembly & Setup

Assembly and Setup provides directions for unpacking and installing your LAC-8 Series oven. Use these assembly and setup instructions for the LFC Series oven as well.

4.1. Unpack & Inspect the LAC-8 Series Oven

Remove all packing materials and thoroughly inspect the oven for any damage that might have occurred during shipment.

- Note condition of carton and plastic cover sheet inside carton.
- Observe all outside surfaces and corners of the oven for scratches and dents.
- Check oven controls and indicators for normal movement, bent shafts, cracks, chips or missing parts such as knobs and lenses.
- Check the door and latch for smooth operation.

	<p>Caution!</p> <p><i>Do not tilt oven while lifting or lift oven using the door handle to prevent damage to the oven and/or personnel involved.</i></p>
---	---

	<p>Caution!</p> <p><i>Do not risk injury when lifting equipment. Take proper precautions when lifting, carrying or otherwise maintaining heavy items.</i></p>
--	--

<p>Notice</p>	<p>How to lift the different sizes of ovens:</p> <ul style="list-style-type: none">• LAC1-38: Four people lift oven's lower corners and place on wheeled transport pallet. Push pallet to desired site and lift oven from pallet, again using lower corners.• LAC1-67, LAC2-12 & LAC2-18: Do not lift by hand. Lift with fork lift and transport pallet.
----------------------	--

4.1.1. If Damaged During Shipping

If damage occurred during shipping:

1. Contact the shipper immediately and file a written damage claim.
2. Contact Despatch Industries (**1-800-473-7373** or **1-952-469-8230** or **service@despatch.com**) to report your findings and to order replacement parts for those damaged or missing. Send a copy of your filed damage claims to Despatch industries (**Despatch Industries, 8860 207th Street, Lakeville, MN 555044, USA**).

Copyright © 2018 by Despatch Industries.

All rights reserved. No part of the contents of this manual may be reproduced, copied or transmitted in any form or by any means including graphic, electronic, or mechanical methods or photocopying, recording, or information storage and retrieval systems without the written permission of Despatch Industries, unless for purchaser's personal use.

3. Check the packing list to ensure you received all the specified components of the oven system. If any items are missing, contact Despatch Industries to have missing products forwarded to you. Your shipment should include:
 - One (1) Despatch oven
 - One (1) Instruction manual and Protocol 3 Manual
 - Two (2) Shelves

4.2. Set-Up the LAC-8 Series Oven

4.2.1. Select Oven Location/Operating Environment

The Despatch LAC-8 Series oven is designed to operate in an industrial setting. Despatch recommends the following environmental operating guidelines:

1. Place the oven on a flat, level solid foundation and secure it to prevent unintended movement.
2. Do not expose the oven to excessive external vibration.
3. Keep equipment away from flammable materials.
4. Do not remove electrical cabinet covers.
5. Where excessive particulate matter is present, such as on a construction site or coal processing, Despatch recommends periodic (usually monthly) cleaning of all electrical compartments.
6. Ensure the power supply meets Despatch specifications. If the facility power supply is not stable, Despatch recommends a line conditioner.

4.2.2. Set-up Procedure

	<p>Warning!</p> <p><i>All grounding and safety equipment must be in compliance with applicable codes, ordinances and accepted safe practices.</i></p>
---	--

	<p>Warning!</p> <p><i>Do not use the oven in wet, corrosive or explosive atmospheres unless this oven is specifically designed for a special atmosphere.</i></p>
---	---

	<p>Caution!</p> <p><i>Do not tilt oven while lifting or lift oven using the door handle to prevent damage to the oven and/or personnel involved.</i></p>
---	---

Copyright © 2018 by Despatch Industries.

All rights reserved. No part of the contents of this manual may be reproduced, copied or transmitted in any form or by any means including graphic, electronic, or mechanical methods or photocopying, recording, or information storage and retrieval systems without the written permission of Despatch Industries, unless for purchaser's personal use.

	<p>Caution!</p> <p><i>Do not risk injury when lifting equipment. Take proper precautions when lifting, carrying or otherwise maintaining heavy items.</i></p>
---	--

<p>Notice</p>	<p>How to lift the different sizes of ovens:</p> <ul style="list-style-type: none">• LAC1-38: Four people lift oven's lower corners and place on wheeled transport pallet. Push pallet to desired site and lift oven from pallet, again using lower corners.• LAC1-67, LAC2-12 & LAC2-18: Do not lift by hand. Lift with fork lift and transport pallet.
---------------	--

1. Place oven on bench top or optional cabinet base.
 - a. Ensure a minimum of six (6) inches (15.3 cm) clearance in the rear of oven to provide proper ventilation. The oven may be placed next to another cabinet, or next to another oven, with three (3) inch (7.6 cm) clearance (the doors will still open).
 - b. Ensure oven is level and plumb for proper heat distribution and operation of all mechanical components.
2. Identify correct power source indicated on the specification nameplate.
3. Plug or hardwire oven directly to the electric supply.
4. To optimize the user experience, and protect the contents of the oven, it is recommended the oven be secured to the table/bench on which it is placed. This can be accomplished by installing a fastener through the rear horizontal flange to the mounting surface. Alternately the shipping straps (straps engaged through the four oven feet and that secured the oven to the shipping pallet) can be used.

4.2.3. Wiring & Power Connections

	<p>Read the Model LAC-8 name plate (top of oven or top of control area under the door) for proper power requirements before proceeding with wiring and power connections. See example below (Figure 9).</p>
---	--

	<p>Danger!</p> <p>All grounding and safety equipment must be in compliance with applicable codes, ordinances and accepted safe practices.</p>
---	---

Copyright © 2018 by Despatch Industries.

All rights reserved. No part of the contents of this manual may be reproduced, copied or transmitted in any form or by any means including graphic, electronic, or mechanical methods or photocopying, recording, or information storage and retrieval systems without the written permission of Despatch Industries, unless for purchaser's personal use.

Models 1-38, and 1-67 come equipped with an appropriate plug and cord. Models LAC 2-12 and 2-18 must be hardwired to the electric supply using 10 AWG or larger wires suitable for at least 75 °C (167 °F).

Despatch	
SERVICE (U.S.): 1-800-473-7373	
SERVICE (INT): 1-952-469-8230	
WEBSITE: WWW.DESPATCH.COM	
MODEL :	LAC2-18-7
SERIAL NUMBER:	184405
MAX TEMP:	260°C / 500°F
POWER:	208V-1PH-50/60HZ 26.5 AMPS
HEATER:	4800 WATTS 23.1 AMPS
MOTOR:	(2)-1/4HP 1.4 AMPS EACH

Figure 9. LAC2-18-8 Nameplate.

4.2.3.1. Wire LAC-8 Models 2-12 and 2-18

	<p><i>For units that must be hardwired or where a power cord is shipped loose, run the power lines from the rear of the oven to the front control panel.</i></p>
---	---

1. Run the wire through the clearly marked power cord access port. (Figure 10).

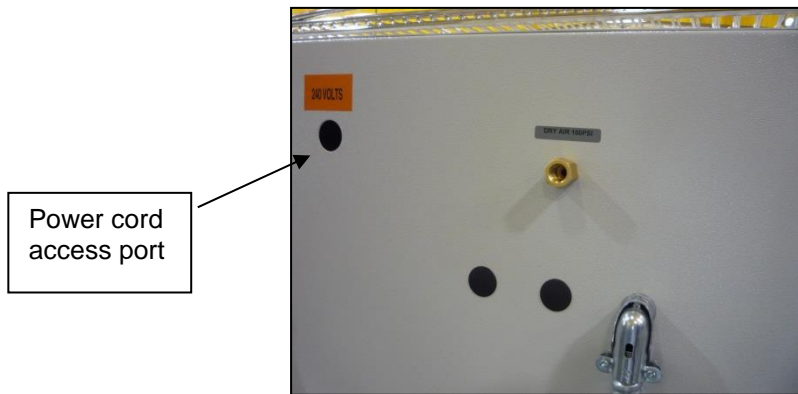

Figure 10. Rear Access Panel for Hard-Wired Connections.

2. Remove the top panel for easy access to power connection, remove controller if necessary for more room and easier access. (Figure 11).



Figure 11. Control panel removal.

3. Connect power at main circuit board, terminals L1 and L2 (Figure 12).
 - a. Tighten terminals on the circuit board to 10.6 to 13.2 lb-in (1.2 to 1.5 Nm)
 - b. Attach the ground wire to the ground buss on the panel.
 - c. Close hinged control panel after attaching the power supply wires or cord.

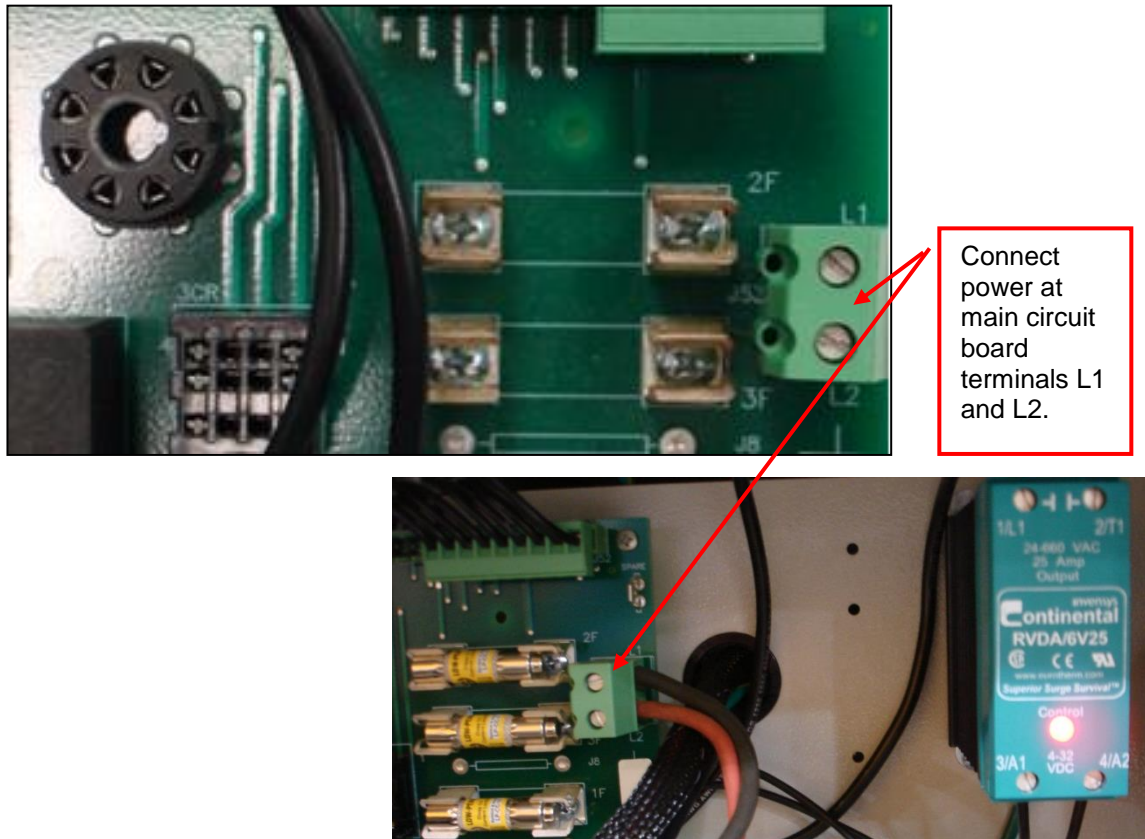



Figure 12. Power Connections at Main Circuit Board.

Copyright © 2018 by Despatch Industries.

All rights reserved. No part of the contents of this manual may be reproduced, copied or transmitted in any form or by any means including graphic, electronic, or mechanical methods or photocopying, recording, or information storage and retrieval systems without the written permission of Despatch Industries, unless for purchaser's personal use.

5. Operation

	<p><i>Users and operators of this oven must comply with operating procedures and training of operating personnel as required by the Occupational Safety and Health Act (OSHA) of 1970, Section 5 and relevant safety standards, and other safety rules and regulations of state and local governments. Refer to the relevant safety standards in OSHA and National Fire Protection Association (NFPA), Section 86 of 1990.</i></p>
---	--

	<p>Warning!</p> <p><i>Do not use the oven in wet, corrosive or explosive atmospheres unless this oven is specifically designed for a special atmosphere.</i></p>
---	---

<p>Notice</p>	<p><i>Before using any cleaning or decontamination method except those recommended by the manufacturer, users should check with the manufacturer that the proposed method will not damage the equipment.</i></p>
---------------	--

5.1. Load Oven

	<p><i>Despatch Industries cannot be responsible for either the process or process temperature used, or for the quality of the product being processed. It is the responsibility of the purchaser and operator to see that the product undergoing processing in a Despatch oven is adequately protected from damage.</i></p> <p><i>Carefully following the instructions in this manual will help the purchaser and operator in fulfilling that responsibility.</i></p>
---	---

	<p>Warning!</p> <p><i>Do not use liquids in the oven. Do not set product or liquids on top of the oven. Liquids that may spill on the oven floor or top of oven may cause considerable damage to the oven.</i></p>
---	---

Copyright © 2018 by Despatch Industries.

All rights reserved. No part of the contents of this manual may be reproduced, copied or transmitted in any form or by any means including graphic, electronic, or mechanical methods or photocopying, recording, or information storage and retrieval systems without the written permission of Despatch Industries, unless for purchaser's personal use.

Avoid spilling on the oven floor when loading the oven. Do not place the load on the oven floor plate. Placing the load on the oven floor may cause the load to heat unevenly. Use the shelves provided.

	<p>Caution!</p> <p><i>Always place loads on the shelves provided to avoid possible uneven heating and damage to the oven.</i></p>
---	--

The two shelves are designed to be pulled out about halfway without tipping. Do not overload the shelves (Refer to Support Capacity listed in Section 1.5.3). Distribute the workload evenly so airflow is not restricted. Do not overfill your oven. The workload should not take up more than two-thirds of any dimension of the inside cavity.

5.2. Pre-Startup Checklist

	<p>Warning!</p> <p><i>Do not use flammable solvent or other flammable material in the LAC oven. Do not process closed containers of any substance or liquid in this oven because they may explode under heat.</i></p> <p><i>The LFC may be operated with solvents, but only up to the rating specified in this manual.</i></p>
--	---

- Know the system. Read this manual carefully. Make use of its instructions and explanations. Safe, continuous, satisfactory, trouble-free operation depends primarily on your degree of understanding the system and your willingness to keep all parts in proper operating condition.
- Check line voltage. Voltage must correspond to nameplate requirements of motors and controls. A wrong voltage can result in serious damage. Refer to Section 1.5.4 for more information.
- Check fresh air and exhaust openings. Do not be careless about restrictions in and around the fresh air and exhaust openings and stacks. Under no condition can they be permitted to become so filled with dirt that they reduce airflow.
- Ventilation. An exhaust opening in the rear of the unit is covered by a hat bracket. Do not remove the hat bracket as it protects the exhaust opening from being completely covered.
- For drying ovens, open vent to prevent buildup of moisture.
- For simple heating, close vent when no ventilation is required.

Copyright © 2018 by Despatch Industries.

All rights reserved. No part of the contents of this manual may be reproduced, copied or transmitted in any form or by any means including graphic, electronic, or mechanical methods or photocopying, recording, or information storage and retrieval systems without the written permission of Despatch Industries, unless for purchaser's personal use.

5.3. Operating Procedure

	<p><i>For fastest oven heat-up time, close the fresh-air vent. After the desired temperature is reached, the vent may be adjusted as needed.</i></p>
---	---

5.3.1. Start Oven

1. Start fan
 - a. Open oven door
 - b. Press Power Switch to ON (Figure 1). Listen for the recirculating fan to start.
 - c. Shut oven door
 - d. Check that control display turns ON.
2. Operate temperature control as desired by following the control operation instructions to follow.

<p>Notice</p>	<p><i>The heater of the Class A oven cannot be energized until the forced exhaust system has brought in a minimum amount of fresh air into the chamber. The purge timer provided prevents the heater from energizing until the oven has had enough time to bring in the required amount of fresh air. The airflow switch, which closes when the exhaust system is running, energizes the purge timer.</i></p>
----------------------	--

5.3.2. Working with Protocol 3 Operating Modes

Refer to the Protocol 3 Controller Owner's Manual for specifics on working with the controller.

6. Maintenance

Only qualified and trained personnel should perform maintenance or repair. Maintenance tasks should be performed with appropriate proper personal protective equipment (PPE). Appropriate PPE includes safety glasses, rubber gloves for handling chemicals, high-temperature gloves for handling hot parts, and a dust mask for working with insulation.

	<p>Danger!</p> <p><i>Use PPE and follow standard safety protocols when working with solvent and other chemicals.</i></p>
---	---

	<p>Warning!</p> <p><i>Do not attempt any service on this oven before opening the main power disconnect switch.</i></p>
---	---

	<p>Warning!</p> <p><i>Do not place this oven in an environment harmful to electrical components.</i></p> <p><i>Placing this oven in an environment detrimental to electrical components (for example, environments where carbon fibers, coal dust or similar contaminants may be present) may result in component failure.</i></p> <p><i>Do not use liquids in the oven. Do not set product or liquids on top of the oven. Liquids that may spill on the oven floor or top of oven may cause considerable damage to the oven.</i></p> <p><i>Contact Despatch for options available to help prevent such failures.</i></p>
---	--

6.1. Checklist

- **Keep equipment clean.** Gradual dirt accumulation retards airflow. A dirty oven can result in unsatisfactory operation such as unbalanced temperature in the work chamber, reduced heating capacity, reduced production, overheated components, and the like. Keep the walls, floor and ceiling of the oven work chamber free of dirt and dust. Floating dust or accumulated dirt may produce unsatisfactory work results. Keep all equipment accessible. Do not permit

Copyright © 2018 by Despatch Industries.

All rights reserved. No part of the contents of this manual may be reproduced, copied or transmitted in any form or by any means including graphic, electronic, or mechanical methods or photocopying, recording, or information storage and retrieval systems without the written permission of Despatch Industries, unless for purchaser's personal use.

other materials to be stored or piled against it.

- **Protect controls against excessive heat**—particularly controls, motors or other equipment containing electronic components. Temperatures greater than 51.5°C (125°F) should be avoided.
- **Inspect user interface areas** – Inspect door and door hardware periodically to insure safe operation.
- **Establish maintenance and checkup schedules.** Do this promptly and follow the schedules faithfully. Careful operation and maintenance will be more than paid for in continuous, safe and economical operation.
- **Maintain equipment in good repair.** Make repairs immediately. Delays may be costly in added expense for labor and materials and in prolonged shut down.
- **Check that safety devices** are ON and enabled.
- **Practice safety.** Make it a prime policy to know what you are doing before you do it. Make **caution, patience, and good judgment** the safety watchwords for the operation of your oven.

6.2. Test Airflow Switch and Purge Timer (LFC only; safety)

The LCD airflow switch recirculation fan, airflow switch exhaust fan, and purge timer should be tested every 40 hours. To test the airflow switch and purge timer:

1. Allow the oven to stabilize at its minimum operating temperature by turning the heater off. Place all dampers in the closed position.
2. Cycle power to the system.
3. The airflow switch should be closed, but the heater relay should remain de-energized until the purge timer times out. This can be verified by monitoring the purge timer.

Indicators 1LED and 2LED should be lit. 3LED should remain off until the purge timer times out.

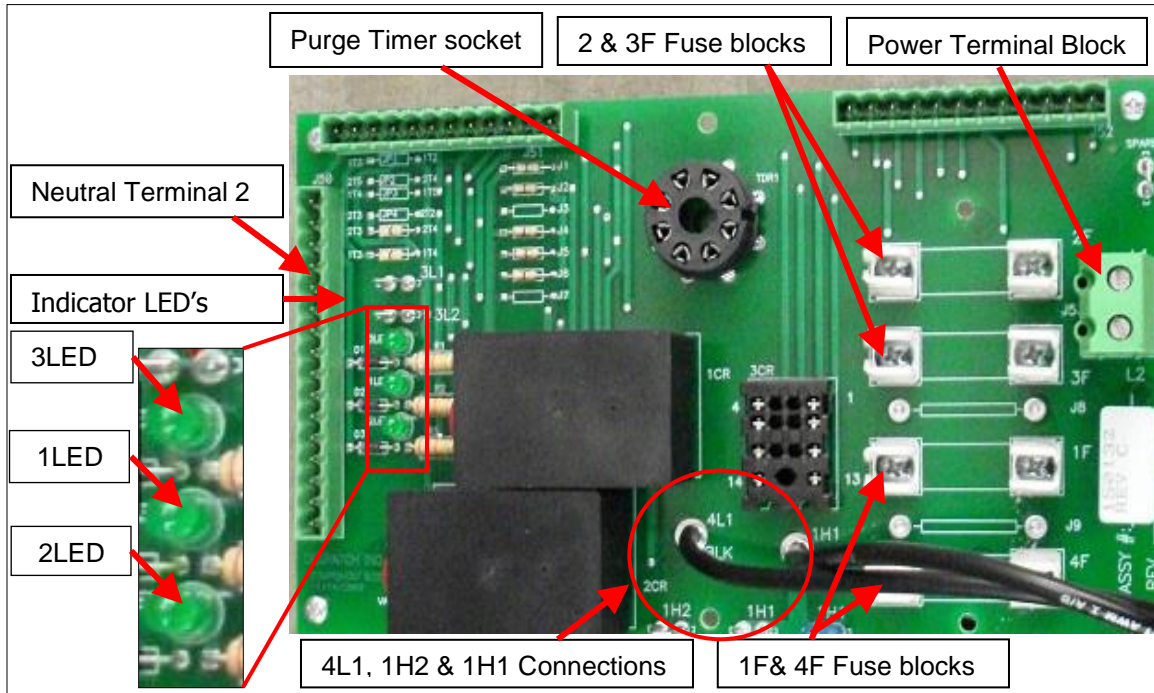



Figure 13. Circuit Board.

6.3. Lubrication

Fan motor bearings are permanently lubricated. All door latches, hinges, door operating mechanisms and bearing or wear surfaces should be lubricated to ensure easy operation.

6.4. Cleaning and Decontamination

6.4.1. Cleaning the LAC-8 Series Oven

	<p>Warning!</p> <p><i>Do not clean oven without first disconnecting power.</i></p>
---	---

For best product results, clean the oven monthly. To clean the oven:

1. Wipe all surfaces with a moistened towel or use a neutral cleaning agent.
2. Use a moistened towel to remove cleaning agents when finished.
3. Dry oven completely before turning it on again.

Clean stainless steel surfaces quarterly. To clean stainless steel surfaces:

1. Wash steel surface using a polyurethane cloth or sponge with clean water and liquid detergent.

Copyright © 2018 by Despatch Industries.

All rights reserved. No part of the contents of this manual may be reproduced, copied or transmitted in any form or by any means including graphic, electronic, or mechanical methods or photocopying, recording, or information storage and retrieval systems without the written permission of Despatch Industries, unless for purchaser's personal use.

Notice	<p><i>Clean quickly for maximum surface protection.</i></p> <p><i>Using water that contains chlorine or hydrochloric acid to clean may damage the oven. Choose a neutral cleaning agent instead.</i></p>
---------------	--

6.4.2. Decontaminating the LAC-8 Series Oven

	<p>Warning!</p> <p><i>Do not decontaminate oven without first disconnecting power. Ensure adequate personal safety while decontaminating oven.</i></p>
---	--

Notice	<p><i>Before using any cleaning or decontamination method except those recommended by the manufacturer, users should check with the manufacturer that the proposed method will not damage the equipment.</i></p>
---------------	---

For best results, decontaminate the work zone daily.

1. Wipe all work surfaces with an appropriate disinfectant.
2. Use a neutral cleaning agent. Do not use acidic or chlorine cleaning detergents as they may damage or corrode the oven.

	<p><i>If necessary, remove highly contaminated inner chamber parts for cleaning or exchange.</i></p>
---	---

	<p>Danger!</p> <p><i>Explosive gases may form during decontamination. Dry and ventilate oven before start-up to avoid explosions.</i></p>
---	---

Copyright © 2018 by Despatch Industries.

All rights reserved. No part of the contents of this manual may be reproduced, copied or transmitted in any form or by any means including graphic, electronic, or mechanical methods or photocopying, recording, or information storage and retrieval systems without the written permission of Despatch Industries, unless for purchaser's personal use.

6.5. Routine Tests

Test LAC-8 Series oven functions regularly and carefully for best performance. Safety of personnel and maintenance of your equipment may depend on the proper operation of any of the temperature control functions.

- Check that the heater LED is cycling on and off, indicating the heater is working.
- Check the High Limit function to make sure it is working properly:
 1. Press **Select** and go to Manual Mode. Enter a control setpoint value at least 11°C (20°F) lower than the current process temperature.
 2. Press **Menu** and lower the High Limit setpoint to a value just below the current process temperature.
 3. Press **Run**.
 4. The High Limit alarm indicator will flash and a High Limit alarm message will display.
 5. Press **Stop**.
 6. Press **Reset**.
 7. Return the control setpoint and High Limit setpoint values to their original values.

6.5.1. Recirculation and Exhaust Airflow Switch Test Operation

1. Turn oven main power switch to OFF.
2. Verify that indicator flag on the exhaust and recirculation airflow switches are in the OFF position (Figure 14).
 - 2.1. When the switch is in the OFF position the electrical contacts within the airflow switch are open, preventing the oven heater from operating.
3. Turn power to oven on
 - 3.1. With oven at ambient temperature, inspect airflow switch indicator to verify that it moves upward to the ON position.
 - 3.2. When the airflow switch moves to the ON position, the electrical contacts will close. The contacts are part of the safety circuit that allows the heater to operate.

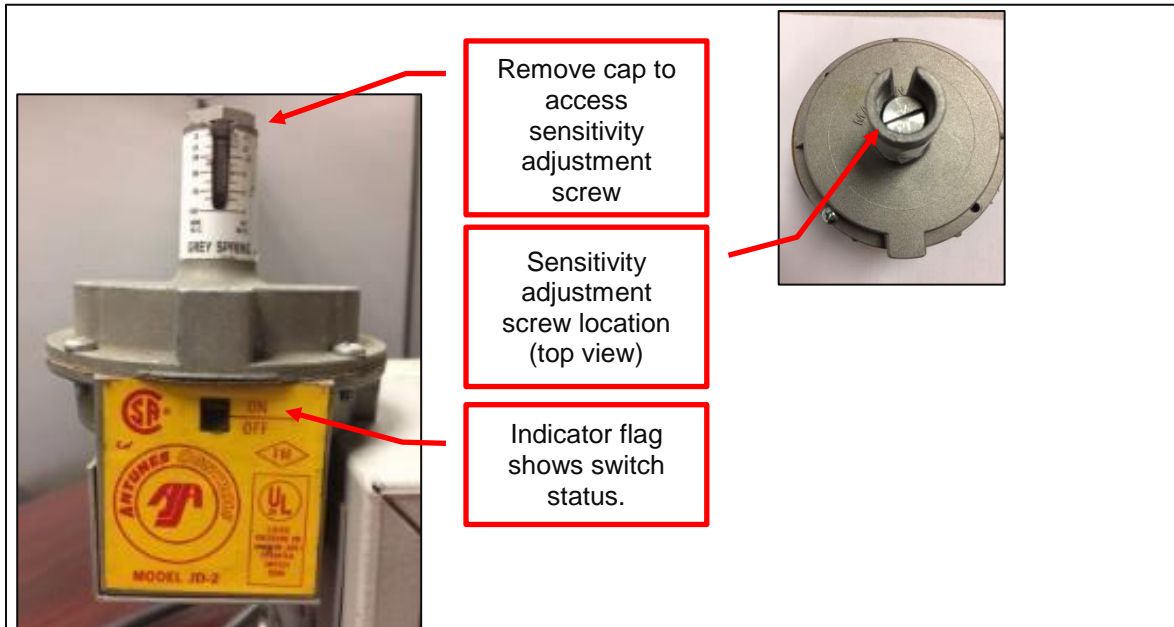

Figure 14. Test Recirculation and Exhaust Airflow Switches.

6.5.1.1. Alternative Method of Checking Power, Switches and Timer

Three LED lights on a circuit board indicate the status of power, airflow switches, and purge timer. These LEDs serve as indicators if the switches are in the ON/Closed position when the main oven power is switched ON.

Locate the circuit board behind the front control (Figure 15):

- 1LED illuminates when the main oven power switch is turned ON
- 3LED illuminates when all the air flow switch contacts are closed
- 2LED illuminates after the purge timer times out

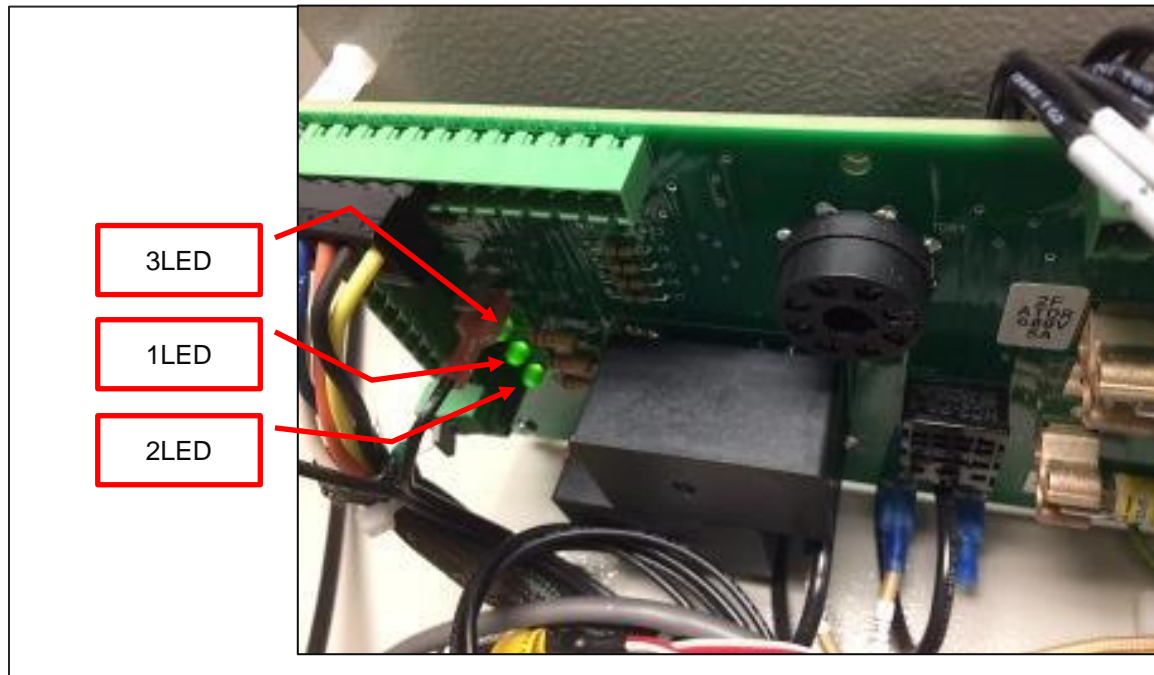

Figure 15. Oven Control Circuit Board LEDs indicate status of switches.

6.5.1.2. Recirculation And Exhaust Airflow Switch Adjustment

After performing the steps in Section 6.5.1, the airflow switches should be:

- OFF/Open when the main oven power is set to OFF
- ON/Closed when the main oven power is set to ON

Optional: Adjust Airflow Switch

If, after performing the steps in Section 6.5.1, the airflow switches are not in the OFF/Open position when the oven is OFF or are not in the ON/Closed position when the oven is turned ON, use the following procedure to adjust the airflow switch sensitivity:

1. Remove the threaded cap located at the top of the airflow switch to gain access to the sensitivity adjustment screw (Figure 14).
 - 1.1. Adjust the screw using a flat blade screwdriver.
2. If switch does not move to the OFF/Open position when oven fans are set to OFF during Step 2 (Section 6.5.1),
 - 2.1. Set main oven power to OFF
 - 2.2. Slowly turn the airflow spring adjustment screw clockwise until the indicator flag moves to the OFF position.
 - 2.3. If the indicator flag cannot be moved to the OFF position by clockwise adjustment of the screw, the unit is bad and must be replaced.
3. If switch does not move to the ON/Closed position during Step 3 (Section 6.5.1),

Copyright © 2018 by Despatch Industries.

All rights reserved. No part of the contents of this manual may be reproduced, copied or transmitted in any form or by any means including graphic, electronic, or mechanical methods or photocopying, recording, or information storage and retrieval systems without the written permission of Despatch Industries, unless for purchaser's personal use.

- 3.1. Start oven fans and then slowly turn the adjustment screw counter clockwise until the indicator moves to the ON/Closed position.
4. Once the airflow switch is adjusted so it is repeatable in turning ON/OFF when the oven fans are set ON or OFF,
 - 4.1. Heat the oven to normal maximum operating temperature
 - 4.2. Verify the airflow switch remains in the ON position

The airflow switch has a normal tendency to turn OFF as the oven is heated, due to the air becoming less dense, which reduces the airflow signal to switch. If the airflow switch opens while the oven is heating, adjust the switch to a lower threshold by turning the adjuster screw counterclockwise while observing the indicator flag. Once the switch moves to the ON/closed position, repeat Steps 1-3 (Section 6.5.1).

6.5.1.3. Summary Switch Conditions

In summary the switch must be set to satisfy two conditions:

- The switch must open when the oven fans are set to OFF.
- The switch must close when the oven fans are set to ON/Closed. The switch must remain ON/Closed when the oven is heated.

If the switch cannot be adjusted to meet both of these conditions the switch is faulty and must be replaced

6.6. Door Adjustment

The LAC-8 utilizes a robust spring-loaded latch mechanism for securing the door against the seal. To optimize the user experience, and protect the contents of the oven, it is recommended the oven be secured to the table/bench on which it is placed. This can be accomplished by installing a fastener through the rear horizontal flange to the mounting surface. Alternately the shipping straps (straps engaged through the four oven feet and that secured the oven to the shipping pallet) can be used.



Figure 16: Shipping anchors



Figure 17: Wall separator/anchor

To increase or decrease latch tension slightly, or to gain a better door seal on the latch side:

- Turn the door strike in or out on its threads by loosening the Allen head set screw.
- If necessary, adjust the vertical alignment of the strike to increase or decrease latch tension.
 1. Loosen the two screws on the latch strike and sliding the strike up or down on its slots.
 2. After positioning the strike, tighten the screws.

If more robust tension is desired for the door actuation, the latch is modifiable by removing from the oven body and replacing with heavier springs. These parts are available on the service page of the Despatch website indicated below.



Figure 18: Latch Adjustment



Figure 19: Spring removal

6.7. Replacement Parts

To order or return parts, contact Despatch Service & Technical Support. When returning parts, a Despatch representative will provide an MRA (Material Return Authorization) number. Attach the MRA number to the returned part for identification. When ordering parts, expedite the process by giving the model number, serial number and part number.

Copyright © 2018 by Despatch Industries.

All rights reserved. No part of the contents of this manual may be reproduced, copied or transmitted in any form or by any means including graphic, electronic, or mechanical methods or photocopying, recording, or information storage and retrieval systems without the written permission of Despatch Industries, unless for purchaser's personal use.

Global Headquarters	Contact	Service & Technical Support & Parts
Despatch Industries 8860 207th Street Lakeville, MN 55044 USA	International/Main: 1-952-469-5424 US toll free: 1-888-337-7282 Fax: 1-952-469-4513 info@despatch.com www.despatch.com	Service: 1-952-469-8230 US toll free: 1-800-473-7373 Fax: 1- 952-469-8193 Service @despatch.com usparts@itweae.com

	<p>Warning!</p> <p><i>Disconnect the main power switch or power cord before attempting any repair or adjustment.</i></p>
---	---

6.7.1. Replace the Protocol 3 Controller

Refer to the Protocol 3 Owner's Manual for instructions on replacing the Protocol 3 controller.

6.7.2. **Replace Heater Unit**

Tools needed: 3/8" wrench, T20
Torx bit driver

1. Remove the ceiling plate.
 - a. Remove the screws from the plate (Figure 20).



Figure 20. Remove Screws to Remove Ceiling Plate.

- b. Slide the ceiling plate out of the oven to expose heater panel/inlet cone (Figure 21).

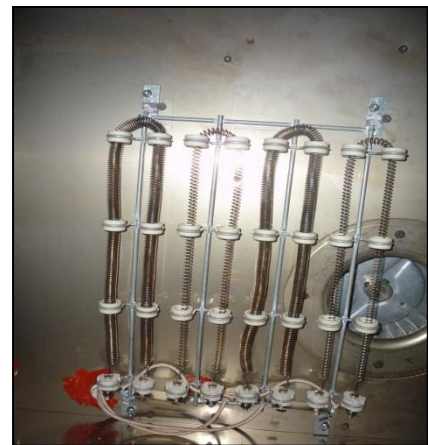

Figure 21. Heater Panel and Inlet Cone.

2. Disconnect the heater leads from heater element with wrench.



Before disconnecting leads, carefully diagram (or note) which wires connect to which terminals.

3. Unscrew the screws holding the heater frame to the oven body (Figure 22).
4. Remove heater and discard.
5. Screw down the new heater frame.
6. Attach the heater leads to appropriate terminals.
7. Replace and screw in interior ceiling panels.



Figure 22. Remove Heater Panel by Removing Screw in Front Edge of Each Panel.

6.7.3. Replace Fan Motor

Tools needed: T20 Torx bit driver, 5/32 inch Allen wrench, one quarter (1/4) inch socket set

1. Open top panel to expose electrical cabinet.
2. Disconnect the motor leads from motor element with wrench.
3. Unscrew the screws holding the motor frame to the oven body
4. Unplug the motor harness from the circuit board and remove motor ground wires from ground stud.



Before disconnecting leads, carefully diagram (or note) which wires connect to which terminals.

5. Remove the fan motor.
6. Install the fan motor.
 - a. Insert shaft seal onto shaft.
 - b. Insert the shaft into shaft collar.
 - c. Fasten motor to plug assembly.
7. Install fan wheel onto motor shaft.
8. Replace and fasten the fan inlet cover.
9. Adjust the fan wheel for 3/16 inch clearance between the wheel and the inlet ring and tighten the set screws on the fan wheel. Check that the set screws hit the flats machined into the motor shaft.
10. Replace fan and heater plug assembly in oven body.
11. Connect motor wire harness and fasten motor ground wires to ground stud.
12. Replace panel and top cover.

Copyright © 2018 by Despatch Industries.

All rights reserved. No part of the contents of this manual may be reproduced, copied or transmitted in any form or by any means including graphic, electronic, or mechanical methods or photocopying, recording, or information storage and retrieval systems without the written permission of Despatch Industries, unless for purchaser's personal use.

7. Troubleshooting

7.1. Troubleshooting Symptoms

Table 2 lists symptoms, probable causes and suggested remedies. Table 3 shows how to troubleshoot the control panel mounted circuit board.

Table 2. Troubleshooting Oven Symptoms.

Symptom	Possible Cause	Next Step
Failure to heat or heats to only 35-50 degrees C	No power	Check power source and/or oven and wall fuses.
	Broken or frayed cord	Replace with new cord.
	Burned out heater	Replace heater (see Warranty Section 8.1).
	Protocol 3 controller malfunction	Replace controller.
	Loose wire connections	Disconnect power and check connections behind control panel.
	Heater relay failure	Replace circuit board. Or SCR
	Airflow switch malfunction	Refer to Section 6.5.1
	Door switch failure	Replace door switch.
Slow heat-up	Improperly loaded	Reduce load or redistribute load in chamber.
	Low line voltage	Supply sufficient power and proper connections. Check for circuit overload.
	Heating element(s) are burned out	Replace burned out element (see Warranty Section 8.1).
	240 volt oven is connected to a 208V line	Raise line voltage to a 240 volt line or modify oven for 208V operation (consult factory).
	Fan motor failure	Replace fan motor.
Frequent heater element out	Harmful fumes generated by load	Increase vent opening or discontinue process.
	Splattering of material on heater elements	Disconnect power and clean oven chamber and elements.
	Overheating oven	Check the High Limit.
Erratic or inaccurate temperature	Fan motor failure	Replace fan motor
	Protocol 3 controller malfunction	Replace Protocol 3 controller.
	Improper tuning parameters	Check tuning parameters.
	Protocol 3 controller miscalibration	Recalibrate Protocol 3 controller (See Protocol 3 Owner's Manual, sections on Calibration).
	High Limit setting	High Limit should be 10-25°C higher than setpoint.
Excess surface or door temperature	Improper offset	Check zone calibration.
	Door seal deterioration	Replace door seal.
Improper airflow	Oven Over pressurization	Close fresh air damper or on LFC open exhaust damper.
	Fan motor failure	Replace fan motor.
	Fan wheel seated too low on fan shaft	Adjust fan wheel for 3/16" clearance between wheel and inlet ring.

Copyright © 2018 by Despatch Industries.

All rights reserved. No part of the contents of this manual may be reproduced, copied or transmitted in any form or by any means including graphic, electronic, or mechanical methods or photocopying, recording, or information storage and retrieval systems without the written permission of Despatch Industries, unless for purchaser's personal use.

Symptom	Possible Cause	Next Step
	Unbalanced fan wheel	Replace fan wheel.
Excessive vibration	Dirty fan wheel	Clean fan.
	Unbalanced fan wheel	Replace fan wheel.
Oven will not control at setpoint	High Limit set too low	Set the High Limit higher.
	Protocol 3 controller malfunction	Check controller settings or replace controller.
	SSR malfunction	Replace SSR and/or check control output voltage.
	Air friction of recirculation fan	Open fresh air or exhaust air vent. Unit will not control below minimum operating temperature with vent closed.
Heater does not shut down until temp. reaches the High Limit setting	Protocol 3 controller malfunction	Replace Protocol 3 controller.
	SSR malfunction	Replace SSR.



Danger!

Table 3 lists troubleshooting steps that must be performed by a qualified electrician or electrical technician trained on electrical safety and the use of personal protective equipment.

Table 3. Troubleshooting with Control Panel Mounted Circuit Board.

If LED is...			Check...
1LED	2LED	3LED	
Not Lit			Check Fuse Block 2F and 3F (Figure 13)
Lit	Not lit	Lit	<ul style="list-style-type: none"> • Check High Limit • Check optional door switch, if appropriate
Lit	Not lit	Not lit	<ul style="list-style-type: none"> • Check air flow switch on LFC ovens.
Lit	Lit	Lit	<ul style="list-style-type: none"> • Check Fuse Block 1F and 4F (Figure 13) • Check SSR • Check heater • Check heater relays

Copyright © 2018 by Despatch Industries.

All rights reserved. No part of the contents of this manual may be reproduced, copied or transmitted in any form or by any means including graphic, electronic, or mechanical methods or photocopying, recording, or information storage and retrieval systems without the written permission of Despatch Industries, unless for purchaser's personal use.



Danger!

Electrical panels contain high voltage. Turning the power switch off on the oven does not de-energize the circuit board. Disconnect and lock out the power supply before working on the circuit board. Failure to lock out the power supply can result in death or injury.

7.2. Troubleshooting Error Messages and Alarms

Table 4 lists the more common error messages, possible problems and remedies.

Table 4. Error Messages and Next Steps.

Alarm Status	Possible Problem	Next Step
HI LIMIT LED ON	<ul style="list-style-type: none"> • Problem with thermocouple • High Limit setpoint has been exceeded. 	Once the problem has corrected, press RESET .
DEV HOLD LED flashing	Oven temperature has not entered (or dropped out of) the Auto Hold band and the soak timer has stopped	Program a slower ramp rate or if oven is not heating check heater circuit.
Top PV displays OPEN	Control thermocouple is disconnected or broken	Repair or replace the thermocouple.
HLPV displays OPEN	High Limit thermocouple is disconnected or broken	Repair or replace the thermocouple.

8. Appendices

8.1. Standard Products Warranty

Also found in proposal and online at
http://www.despatch.com/pdfs/standard_warranty.pdf.

Despatch Standard Products Product Warranty

Products Covered by this Warranty

This warranty (the "Warranty") applies to the following Despatch branded products: LBB, LAC, LFC, LCC, LCD, RAD, RFD, RQD, TAD, TFD, RBC, PBC, PNC, PND, PRVO, PTC, PCC and products as specified in the Despatch proposal. ITW Electronics Assembly Equipment, a division of Illinois Tool Works Inc., is referred to herein as "Despatch".

Parts and Materials

Despatch warrants all parts and materials to be free from defects in material and workmanship for a period of:

1. Five (5) years from date of shipment for laboratory oven electric heaters
2. Two (2) years from date of shipment for Protocol 3 and DES2000 temperature controllers; and
3. One (1) year from the date of shipment, or 2,000 hours of operation, whichever occurs first, for all other components of products covered by this Warranty

During the applicable Warranty period, Despatch will repair or replace, at Despatch's option, parts and materials covered by this Warranty

Labor

During the first one (1) year of the Warranty period, Despatch will pay labor costs incurred to remove defective parts and materials, and to reinstall repaired or replacement parts or materials; provided, however, that Despatch's obligation to pay such labor costs shall be subject to the limitation that the removal and/or reinstallation service must be performed by a Despatch-authorized technician from Despatch's worldwide network of factory-trained professionals at a location within the contiguous United States.

Transportation Costs

All transportation costs to transport defective parts or materials to Despatch and to transport repaired or replacement parts or materials to Customer shall be the responsibility of the Customer.

Terms and Conditions

This Warranty shall be deemed valid and binding upon Despatch if and only if the Customer:

1. Installs, loads, operates, and maintains the covered product supplied hereunder in accordance with the instruction manual provided upon delivery and product labeling affixed to the subject equipment;
2. If applicable, follows the Emergency Procedure set forth in this Warranty; and
3. Contacts Despatch's Helpline at 1-800-473-7373 for assistance in diagnosing and troubleshooting the problem immediately upon discovering any damage or malfunction.

Despatch's reasonable determination as to whether a repair, replacement, or service is covered by this Warranty shall be final and binding.

Exclusions

This Warranty DOES NOT cover:

1. Damage or malfunctions, or expenses incurred in the process of diagnosing and/or repairing damage or malfunctions, resulting from any of the following: operator error, misuse, abuse, inadequate preventive maintenance, normal wear and tear, service or modifications by other than Despatch authorized technicians, use of the covered product that is inconsistent with the operation manual or labeling, acts of nature (including, without limitation, floods, fire, earthquake, or acts of war or civil emergency), internal or external corrosion, or non-conforming utilities (including, without limitation, electrical, fuel supply, environmental and intake/exhaust installations);

2. Repair or replacement of parts or materials designed and intended to be expendable or consumable; refrigerants, filters, lamps;
3. Routine maintenance; or
4. Labor costs incurred for troubleshooting, diagnostics, or testing (except for testing required to verify that a covered defective part or material has been repaired).

Limitations of Liability

Despatch shall not, in any event, be liable for indirect, special, consequential, incidental, or punitive damages or penalties of any kind, including, without limitation loss of revenue, profits or business opportunities resulting from interruption of process or production. In no event shall Despatch be liable for damages in excess of the amounts paid by Customer to Despatch with respect to the applicable product(s). This Warranty does not cover, and Despatch shall not be liable for any losses, costs, damages or expenses resulting from delays in diagnosing or repairing the products, supplying or obtaining replacement parts or materials, strikes, labor stoppages or shortages, fires, accidents, government acts or regulations, or any other causes beyond the control of Despatch.

Non-Compliance by Customer

Despatch reserves the right to suspend and withhold service under this Warranty in the event of non-compliance by the Customer to any terms and conditions of this Warranty or the applicable purchase order or invoice. Further, Despatch shall not be liable for any loss of production, expenses, and inconveniences incurred due to such suspension.

Customer Furnished Equipment Warranty Limitation

This Warranty does not cover diagnosis or repairs of defects in or caused by, lack of performance of, or fitness for purpose of customer-supplied parts or equipment unless specifically noted in the Despatch written order acceptance confirmation.

Performance Commitment

Despatch provides no guarantee of process performance or fitness for purpose, unless specifically noted otherwise in Despatch written order acceptance confirmation. Despatch is providing equipment with design parameters specific only to its equipment.

Procedure upon Discovery of Defects and Emergencies

In the event Customer becomes aware of any defect in the applicable products, Customer must immediately: (a) shut off fuel or energy supply (gas and electricity), (b) call for emergency assistance, if needed, and (c) notify Despatch Service.

THE REPRESENTATION AND WARRANTIES SET FORTH HEREIN ARE EXCLUSIVE AND IN LIEU OF, AND CUSTOMER HEREBY WAIVES AND DISCLAIMS RELIANCE UPON, ALL OTHER REPRESENTATIONS AND WARRANTIES OF EVERY KIND WHATSOEVER, WHETHER EXPRESS OR IMPLIED, OR ARISING BY OPERATION OF LAW OR IN EQUITY, OR BY COURSE OF PERFORMANCE OR DEALING OR USAGE OF TRADE, INCLUDING, WITHOUT LIMITATION, ANY IMPLIED WARRANTIES OF MERCHANTABILITY OR OF FITNESS FOR A PARTICULAR PURPOSE.

THIS WARRANTY IS PERSONAL TO THE CUSTOMER AND MAY NOT BE TRANSFERRED OR ASSIGNED. ALL LIMITATIONS HEREUNDER, HOWEVER, SHALL BE BINDING ON ALL SUCCESSORS AND ASSIGNS OF CUSTOMER.

(7/25/2017)

Ph: 952-469-8230 | Toll Free: 800-473-7373 | service@despatch.com | www.despatch.com

ITW EAE

Copyright © 2018 by Despatch Industries.

All rights reserved. No part of the contents of this manual may be reproduced, copied or transmitted in any form or by any means including graphic, electronic, or mechanical methods or photocopying, recording, or information storage and retrieval systems without the written permission of Despatch Industries, unless for purchaser's personal use.

8.2. LAC-8 Series Oven Options

8.2.1. Optional MRC5000 Recorder Setup

	Refer to instructions provided by the recorder manufacturer for more specific installation notes.
---	--

Temperature is retransmitted to the MRC5000 recorder from the controller. To set up the recorder:

1. Ensure hardware jumper JU1 is in place for the 5 VDC setting (Refer to MRC5000 Manual included).
2. Move MODE to **PROG/TEST/CAL** to display **Prog.**
3. Press ▼ twice to display **Inps**. Move to each Parameter Code using ▼ or ▲. Adjust each Parameter Code using the settings in Table 5.
4. After adjusting all settings, move MODE to **RUN**. Display on both the recorder and controller should read the same.

Table 5. MRC 5000 Settings.

Parameter Code	Degrees C	Degrees F
Inps	18	18
Icor	0	0
diSP	On	On
dPOS	0	0
EUU ⁶	400	752
EUL ⁶	0	32
ChUP	400	800 ⁷
ChLO	0	0
DFF	1	1

⁶ These values must match the settings **RetOutLo** and **RetOutHi** on the Protocol 3 control page. For example, if **RetOutLo** is 32, **EUL** must read 32.

⁷ Change 0-400 chart paper to 0-800 chart paper. Depending on the equipment used, 0-600 paper may be used if the maximum temperature is 500°F.

8.2.2. **Optional Pneumatic and Electronic Door Lock**

The LAC-8 Series oven electronic door lock option prevents the door from being opened if a Protocol 3 controller event is active.

8.2.3. **Optional Interior Light**

The LAC-8 Series oven optional interior light allows users to see inside the oven during operation. The interior lights uses a 50W bulb mounted inside the oven. Control the optional interior light using the ON/OFF switch mounted on the oven control panel (labeled "INTERIOR LIGHT").

8.2.4. **Optional Door Interlock Switch (Controls Heater & Fan)**

The LAC-8 Series oven optional door interlock switch automatically shuts OFF either the heater only or both the heater and fan when the door is opened. This option provides an extra measure of safety for the user.

8.2.5. **Optional High Limit Alarm with Alarm Silence**

The LAC-8 Series oven optional High Limit Alarm provides an audible and visual alarm when the temperature exceeds the High Limit setpoint on the control. The alarm horn is typically located to the right of the control panel door.

When the chamber temperature exceeds the High Limit setting on the control, the heater shuts down, the alarm horn sounds and the red push button switch will illuminate.

To silence the alarm:

1. Depress the **Alarm Silence** switch.
 - a. This silences the alarm horn.
 - b. The red push button switch remains illuminated.
2. Clear the alarm by correcting the High Limit condition.
3. When the High Limit condition clears, press **Reset** on the control. See Protocol 3 Owner's Manual for detailed operation.
4. The red push button switch will go off, the heater switches on and the control is functioning correctly.
5. If the High Limit trips repeatedly, identify the cause and correct the problem.



When the alarm is triggered by the end of cycle, the alarm will continue to be active until another process is started.

8.2.6. **Optional Forced Exhaust**

The LAC-8 Series oven optional forced exhaust allows increased cooling by using an extra fan. The forced exhaust is triggered by an event or by pressing **Exhaust Fan** on the control panel—or both. Find more information about exhaust and the LAC-8 Series ovens in Sections 3.1, 3.2, 5.2 and 8.2.7. If the oven is to be operated with CDA option in combination with a forced exhaust, please consult factory. The oven is safe to operate but measures can be taken to increase the life of electrical components.

	<p>Danger!</p> <p><i>The exhaust fan is open on the top for the purpose of connection to ductwork. A duct or other means of protection must be put in place prior to operation to prevent fingers or other objects from contacting the moving fan.</i></p>
---	---

8.2.7. **Optional Clean Dry Air (CDA)/Nitrogen**

The LAC-8 Series oven optional CDA/Nitrogen provides clean dry air or inert gas for moisture removal. CDA helps drive off moisture. Nitrogen helps drive off moisture and/or provide a light blanket of nitrogen. Using nitrogen does not create low oxygen content—since this is an air unit it always contains a small amount of fresh air exchange and the internal seams are not welded. Flow is controlled by a solenoid valve turned ON or OFF through an Event in the Protocol 3 controller. If the oven is to be operated with CDA option in combination with a forced exhaust, please consult factory. The oven is safe to operate but measures can be taken to increase the life of electrical components.

	<p>Danger!</p> <p><i>Use care when working with nitrogen. Nitrogen presents an asphyxiation hazard. Handle nitrogen according the safe handling procedures listed in the material safety data sheet (MSDS).</i></p>
---	--

	<p>Warning!</p> <p><i>When used in conjunction with the optional forced exhaust fan, insure the exhaust-fan damper is in the open position to prevent the oven pressurization and overheating of electronics.</i></p>
---	--

Copyright © 2018 by Despatch Industries.

All rights reserved. No part of the contents of this manual may be reproduced, copied or transmitted in any form or by any means including graphic, electronic, or mechanical methods or photocopying, recording, or information storage and retrieval systems without the written permission of Despatch Industries, unless for purchaser's personal use.

8.3. *Mechanical Drawings*

See mechanical facility drawings included on the manual CD. The drawings included are intended to be reference only and the latest revision may be found online at www.despatch.com.

8.4. *Electrical Schematics*

See the electrical schematics included on the manual CD. The drawings included are intended to be reference only and the latest revision may be found online at www.despatch.com.

SERVICE AND TECHNICAL SUPPORT

service parts: 1-800-473-7373
international service/main: 1-952-469-8230
service fax: 1-952-469-8193

service@despatch.com
usparts@ltweae.com

GLOBAL HEADQUARTERS

main phone: 1-800-726-0110
international/main: 1-952-469-5424
sales: 1-800-726-0550
international/sales: 1-952-469-8240

sales@despatch.com

www.despatch.com

8860 207th Street West
Minneapolis, MN 55044 USA

Despatch

Thermal Processing Technology **ITW EAE**